



Shiraz  
University

## Field evaluation of a grain drill equipped with jointers for direct planting in previous wheat crop residues

S. Abdollahpour, S.H. Karparvarfard\*

Department of Biosystems Engineering, College of Agriculture, Shiraz University, Shiraz, I. R. Iran

\* Corresponding Author: karparvr@shirazu.ac.ir

### ARTICLE INFO

#### Article history:

Received 5 July 2015

Accepted 27 July 2016

Available online 12 July 2017

#### Keywords:

Direct planting system  
Fuel consumption  
Jointer  
Operation time  
Specific drawbar energy

**ABSTRACT**-In conventional agriculture, a large amount of energy is consumed in fuel consumption and depreciation of farm tractors and any other farm equipment mostly in tillage and planting operations. The main purpose of this research was to evaluate a till-planting unit equipped with three jointers. This unit was expected to act as conventional furrow openers such as shovel openers tilling the soil and plant simultaneously, which could reduce farm traffic and farming costs. The unit performance was compared to that of a grain drill. The control experiment was conducted on a moldboard plowed soil, disked by a tandem disk harrow and planted by a pneumatic grain drill. The experimental site was also covered with previous wheat crop residue and the soil was clay with loam at 15.2% d.b. moisture content. The working depth was 6 and 20 cm for direct planting and conventional system, respectively. The experiments were performed at three tractor forward speeds (4, 6 and 8 km h<sup>-1</sup>) in triplicate in the Experiment Site of Shiraz University, Shiraz, Iran. Results indicated that the direct planting system reduced the operation time, fuel consumption, draft and specific drawbar energy 65, 60, 75 and 80%, respectively as compared to the conventional practice. However, values of the mean weight diameter and seedling growth rate did not show any significant difference in the two cases at 5% level. Furthermore, moisture retention in direct planting system increased 1.87% per 10 days as compared with the conventional farming system.

### INTRODUCTION

Minimum tillage can be defined as "the least amount possible of cultivation or soil disturbance done to prepare a suitable seedbed". This means that the soil is physically minimum inverted. Benefits of min-till systems are reducing production costs, keeping a portion of previous residue on the soil, improving soil structure, eliminating adverse environmental effects (soil erosion and ...), reducing surface evaporation and reducing energy consumption (Tebrugge and Bohrsen 2001; Davies and Finney 2002; Coughenour 2003). Agricultural machinery engineers believe that soil compaction increases soil mechanical resistance and in turn, by increasing the draft, fuel consumption, operation time and the wear of agricultural machinery will increase (Spoor and Godwin, 1978).

Research has shown that about 60% of the mechanical energy used in farm operations is spent for tillage and seedbed preparation. Direct planting in reduced tillage systems is able to cut virgin soil, pass the residues by furrow openers and provide proper contact between the soil and seeds (Graham and Ellis, 1980). Peruzzi et al. (1996) compared different tillage methods including conventional tillage, min-till and no-till in wheat and maize plantings. They used a direct planting machine in min-till method. Results indicated that the average time required to perform min-tillage

and no-till systems was 80% less than the conventional tillage. Four wheat cultivation methods were compared in another research whose results indicated that direct planting machines reduced the total time spent about 76% and fuel consumption about 53% as compared to grain drill planting after four times disking operations by a tandem disk (Taki, 1996).

Conservation tillage eliminates almost all soil erosions and reduces soil losses by preserving soil residue on soil surface (Subbulakshmi et al., 2009). Certain conservation tillage practices can increase soil organic matter, break soil impermeable layer and improve water infiltration (Stroosnijder, 2009).

Chen et al. (2009) reported that mean weight diameter (MWD) at depths of 0–15 cm and 15–30 cm was significantly higher in surface tillage (shallow tillage, 5 cm depth) than in the conventional tillage (moldboard plowing, 15–20 cm depth) system. They also observed that MWD decreased with increasing operation depth in all tillage systems.

The purpose of this study was to evaluate the performance of a direct planting system as compared to the conventional wheat cropping system.

## MATERIALS AND METHODS

Tests were performed using two different tillage-planting systems, direct planting and a conventional system.

### Development of Direct Planter

In grain drill planting, the seeds should be placed in 10-12 cm furrow depth and then, they should be covered by soil. Jointers function is plowing up and throwing on the furrow bottom a certain part of upper layer soil. It could be the best part of direct planting system which is composed of two main units, tillage and planting systems. The tillage unit consists of three jointers which are similar to the moldboard plow, but in smaller dimensions suitable for shallow plowing (Fig. 1). While the width of the common moldboard in bottom conventional system is 30 cm, that of tillage of the jointer may vary in the range of 0.3-0.7 in relation to the width of tillage of the bottom (Bernacki et al., 1972). So, we chose the jointer width bottom of 21 cm on the assumption that the width of cropping lines is a function of jointer shared width and varies in the range of 0.3-0.7 of the width of the jointer; therefore, the row spacing can be chosen as 12 cm.

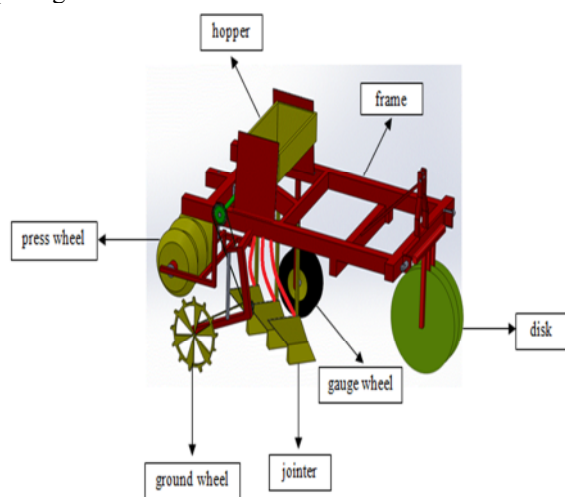

Fig. 1. Layout of the direct planting system used in this study.

In this study, the tillage depth of the bottom was 20 cm. According to Bernacki et al. (1972), the maximum tillage depth of the jointer may vary in the range of 0.3-0.5 of the depth of tillage of the bottom. Hence, the tillage depth was chosen as 6 cm. Steepness of moldboard can be expressed by the relation  $L/H$ , where  $H$  is the height of the moldboard and  $L$  is the slope of the moldboard (Fig. 2).

A total of three jointers were designed and built to open the slot in the soil, throw the seeds in the slot, invert the soil and finally cover the seeds.

An excessive surface residue causes two problems during planting; 1) it can cause congestion in jointers or 2) it can cause lack of proper soil seed contacts. To tackle these problems, it was decided to install fluted rolling coulters on the unit to cut the residues and loosen the soil. Other elements of this system are seed box,

gauge wheel, land wheel and press wheels. Also, the characteristics of moldboard plow (Khorasan Miner Construction Industry, Mashhad, Iran) and the jointer are presented in Table 1.

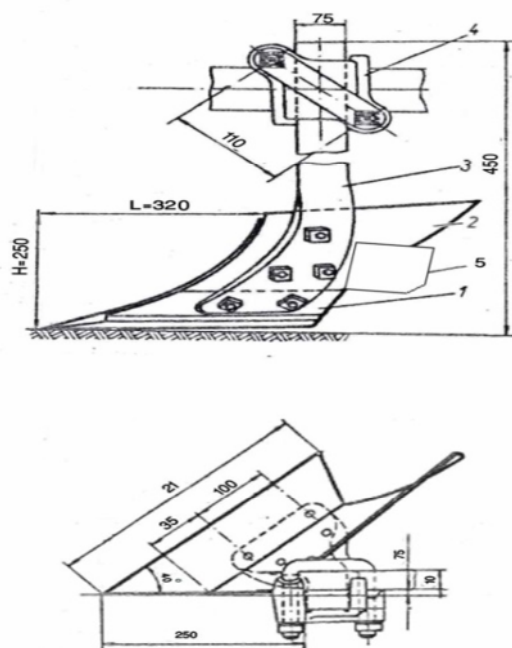

Fig. 2. Jointer: 1- share; 2- moldboard; 3- shank; 4- yoke; 5- drill seed tube holder (all measuring in mm).

### Field Experiments

The conventional system is worked by moldboard plow followed by tandem disk harrow and then planted by pneumatic grain drill. A John Deere trailed type offset grain drill with 24 disks, 15 cm disk spacing and 45 cm disk diameter with a typical pneumatic grain drill was used (Barzegar Machine Co, Hamedan, Iran). The specification of grain drill was: 12.5 cm the inter row spacing, 21 rows and  $0.75 \text{ cm}^3$  volume of the hopper.

Field tests were conducted at three forward speeds (4, 6 and  $8 \text{ km h}^{-1}$ ) and three replications in the research field located in the school of agriculture, Shiraz University. Draft, fuel consumption, specific drawbar energy (SDE), specific fuel consumption (SFC), mean weight diameter (MWD) and relative growth rate (RGR) were measured and compared to parameters obtained from the conventional system. The percentage of surface previous residues retained on the soil was determined using the method proposed by Papendick (2002). The percentage of crop residue on the field was 45. Dimensions of the experimental plots were selected as  $4 \text{ m} \times 40 \text{ m}$ . Soil was sampled at the depth of 0-25 cm to measure the soil moisture content (m. c.), which was 15.2% on dry weight basis. Soil texture was clay loam with 35% sand, 30% silt and 35% clay.

The experiment was conducted in split plots based on randomized block design with three replications. The means were compared using Duncan Multiple Range Test.

**Table 1.** Specifications of moldboard plow and jointer

Mounted Implements	Number of bottom	Cutting width (cm)	Width (cm)	L (cm)	H (cm)	Characteristics					
						L/H	Type of moldboard	Shape of moldboard	Share angles (Degree)		
									Setting	Load	Cutting
Moldboard plow	3	51	30	36	38	0.9	Standard	Semi-cylindrical & semi complex	44	20	50
Jointer	3	21	12	32	25	1.3	Inclined	Helical	40	20	30

**Field Evaluation**

After tillage operation, soil samples were collected from a depth of 0–15 cm with special care to avoid soil clods break-up. A 50 cm × 50 cm frame was used to surround the soil samples which were then air dried for 24 hours. Dried soil samples were subsequently passed without vibration through 6 rotary sieves with 0.625, 1.25, 2.5, 5, 7.5 and 10 cm mesh openings (Kemper and Chepil, 1995). The soil retained on each sieve was weighed and its MWD was calculated for each soil sample according to Eq. (1).

$$MWD = \sum_{i=1}^n (X_i \times W_i) \tag{1}$$

where  $X_i$  is the mean diameter of the holes of the  $i_{th}$  sieve and the upper sieve,  $W_i$  is the clod weight fraction of clod remaining on the  $i_{th}$  sieve as a proportion of the total dry weight of the sample.

In order to measure the tractor fuel consumption, two turbine flow meters (VISION-1000, Remag, Switzerland) were used to measure fuel flow from fuel pump to injectors and also to measure the excess of fuel returned. To determine the net fuel consumption for a particular treatment, fuel flow rates measured by sensors were subtracted. Draft force was measured according to the standards set by RNAM. For this purpose, an S shape loadcell (DEE-5 ton, Keli, China) was installed between two ITM-399 tractors, one of which pulling the second tractor and the mounted equipment. Tests were carried out both with the equipment in the soil and not engaged in the soil. The force readings were used to calculate the net draft by the equipment in working conditions. The drawbar power was calculated by multiplying the drawbar draft and the tractor speed which was measured by two shaft encoders (ES0S8-500-3-N-24, Atonics, South Korea). The values of specific fuel consumption (SFC) and specific drawbar energy (SDE) were calculated by known drawbar power and fuel consumption using equations (3) (Liljedahl et al., 1989), (Jenane et al., 1996) and (2) respectively:

$$SFC = \frac{V_{fc}}{P_d} \tag{2}$$

$$SDE = \frac{P_d}{V_{fc}} \tag{3}$$

where  $V_{fc}$  is the mean fuel consumption rate and  $P_d$  is the drawbar power.

When wheat seedlings were one month old, the dry weights of plant seedling samples were measured at two

time intervals of 12 days. In each interval, the samples were exposed to free air for 5 days in order to reduce their primary moisture. Then, they were placed in an oven at 70° C for 24 hours. Therefore, the relative growth rate (RGR) was calculated from Eq.4 (Noggle and Firtz, 1976);

$$RGR = \frac{\ln W_2 - \ln W_1}{\Delta t} \tag{4}$$

where  $W_2$  is seedling weight after the second 12 days,  $W_1$  is seedling weight after the first 12 days and  $\Delta t$  is the time interval between the two tests.

During 10 days, the soil moisture content was measured daily for the two planting methods. The sampling depth was 0-25 cm. The samples were weighed and instantly placed in an oven dryer for 24 hours at a temperature of 105 ° C. After the drying period, they were weighed again and their moisture content was calculated using Eq. 8 (Ward and Robinson, 1990);

$$m. c. (db)\% = \frac{W_w - W_d}{W_d} \tag{5}$$

where  $W_w$  is the initial weight and  $W_d$  is dry weight of soil.

**RESULTS AND DISCUSSION**

Table 2 shows the results of the analysis of variance in mean of sum squares for the factors included in the experiment. Also, the comparison of the mean values of the experiment variables is given in Table 3.

**Operation Time**

Regarding direct planting system, there was a significantly ( $P < 0.05$ ) lower operating time as compared to the conventional farming system (Table 2). The operation time ratio of direct planting system compared to conventional farming systems was 0.33 for equal hectares. Results indicated that as the speed increased, the operating time reduced for both systems, which is consistent with the results of peruzzi et al. (1996). The average time for reduced tillage and no-till system operations was less than that of the conventional tillage by about 68% (Fig. 3 and Table 3).

**Table 2.** Summary of analysis of variance of the measured variables

Source of variation	Degree of freedom	Mean Squares Time of operations (s)	Fuel consumption (L)	Draft (kN)	SFC (L kw <sup>-1</sup> h <sup>-1</sup> )	SDE (kw h L <sup>-1</sup> )	MWD (mm)	RGR (g day <sup>-1</sup> )
Block (r)	2	19.31 <sup>ns</sup>	0.00007 <sup>ns</sup>	8.7419**	0.0059 <sup>ns</sup>	0.3356***	0.0811 <sup>ns</sup>	0.00009 <sup>ns</sup>
System (a)	1	17496.03***	0.04084***	1146.9***	4.9929***	50.743***	4.5095 <sup>ns</sup>	0.00011 <sup>ns</sup>
Speed (b)	2	2091.75***	0.00171***	9.4838**	0.1895***	1.4965***	45.293*	0.00008 <sup>ns</sup>
System×Speed	2	519.11***	0.00008 <sup>ns</sup>	6.8633**	0.0978***	0.6172**	3.2672 <sup>ns</sup>	0.00009 <sup>ns</sup>
Error	8	11.083	0.00003	0.00003	0.00488	0.03806	3.939	0.00008
CV (%)		5.454	4.663	4.663	9.003	7.879	15.14	9.012

\*, \*\* and \*\*\* significant at 5, 1 and 0.1% respectively, ns indicates no significant difference.

**Table 3.** Comparison of the mean values of experiment variables

Treatment	Planting Speeds (km h <sup>-1</sup> )	Time of operations (s)	Fuel Consumption (L)	Draft (kN)	SFC (L kw <sup>-1</sup> h <sup>-1</sup> )	SED (kw h L <sup>-1</sup> )	MWD (mm)	RGR (g day <sup>-1</sup> )
Direct planting system	4	40.54 <sup>d</sup>	0.08 <sup>d</sup>	4.78 <sup>d</sup>	1.63 <sup>a</sup>	0.61 <sup>d</sup>	14.99 <sup>a</sup>	73.02
	6	26.81 <sup>de</sup>	0.05 <sup>de</sup>	4.87 <sup>d</sup>	1.25 <sup>b</sup>	0.79 <sup>d</sup>	11.72 <sup>b</sup>	74.6
	8	22.23 <sup>e</sup>	0.05 <sup>e</sup>	5.18 <sup>d</sup>	1.02 <sup>bc</sup>	0.97 <sup>d</sup>	11.12 <sup>b</sup>	77.68
Conventional planting system	4	121.73 <sup>a</sup>	0.17 <sup>a</sup>	18.41 <sup>bc</sup>	0.30 <sup>c</sup>	3.30 <sup>c</sup>	17.32 <sup>a</sup>	69.24
	6	88.68 <sup>b</sup>	0.16 <sup>ab</sup>	21.29 <sup>abc</sup>	0.23 <sup>c</sup>	4.22 <sup>b</sup>	12.97 <sup>ab</sup>	76.02
	8	66.23 <sup>c</sup>	0.14 <sup>c</sup>	23.01 <sup>a</sup>	0.20 <sup>c</sup>	4.93 <sup>a</sup>	10.53 <sup>b</sup>	75.27

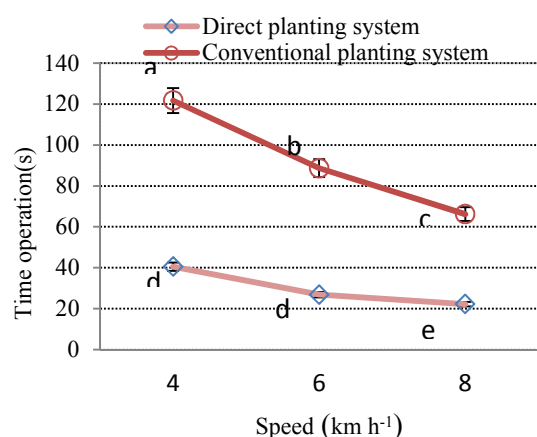

**Fig. 3.** Effect of cropping systems and speed on the average values of operations time. The same letters in columns show no significant differences based on Duncan test ( $p < 0.05$ )

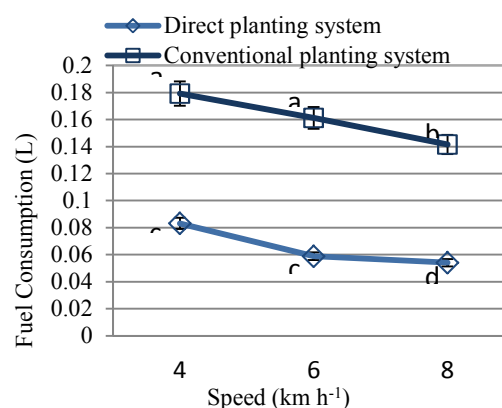
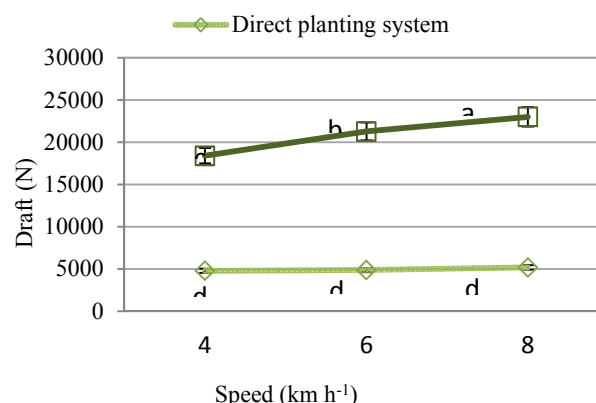

**Fig. 4.** Effect of cropping systems and speed on the average fuel consumption. The same letters in columns show no significant differences based on Duncan test ( $p < 0.05$ )

**Fuel Consumption and Draft Requirement**

Analysis of variance of measured variables showed that the effects of cropping system and speed on the fuel consumption and draft were significant ( $P < 0/01$ ), but the interaction effect of system and speed on the fuel consumption was not significant at 5% confidence level while it had a significant effect on the draft force ( $P < 0/01$ ) (Table 2). For the two systems, by increasing the speed, the draft increased significantly.

In the direct planting system, there was no significant change in drawbar force by increasing the speed. For direct planting system, the numerical values of fuel consumption and drawbar force reduced by 60% and 75%, respectively compared with the conventional farming system (Table 3; Figs. 4 and 5).



**Fig. 5.** Effect of cropping system and speed on the average draft force. The same letters in columns show no significant differences based on Duncan test ( $p < 0.05$ )

This part of the study mainly aimed at assessing the percentage of reduction of fuel consumption rate and draft force in direct planting systems. The importance of these results in addition to stem growth rate increment, organic materials on the top soil, and the increase of soil moisture were the integral parts of this section. A significant reduction of the above-mentioned items could be due to the decline in the planting depth and the systems traffic in the direct planting system, which is in agreement with the results obtained by YounesiAlamouti and Sharifi (2011), Matthes et al. (1988), and Maleki (2002).

**Specific Drawbar Energy (SDE) and Specific Fuel Consumption (SFC)**

The drawbar work per unit volume of fuel consumed means SDE and the mass of fuel consumed per unit of work means SFC (reciprocal value to SDE). (OECD Standards, 2012). Accordingly, the greater value of SFC is more favorable but not for the SDE. Having speed, fuel consumption and draft force data of the SDE and SFC were calculated using equations 2 and 3 (Liljedahl et al., 1989; Jenane et al., 1996). The type of planting system had a significant effect on SDE and SFC at a confidence level of 1% (Table 2).

The interaction effect of direct planting system and speed on the SDE was not significant at 5% of confidence level while it had a significant effect on the SFC ( $P < 0.01$ ). On the other hand, the interaction effect of conventional planting systems and the speed on the SDE were significant at the confidence level of 1%, but they showed no significant effect on the SFC at the confidence level of 5% (Table 2). Generally, by increasing the speed of the two systems, the values of SDE and SFC increased respectively and decreased significantly. The numerical value of SDE in the direct planting system was reduced about an average of 78% compared with the conventional system while the values of SFC in the direct seedling system increased about an average of 82% compared with the conventional system (Table 2; Figs. 6 and 7).

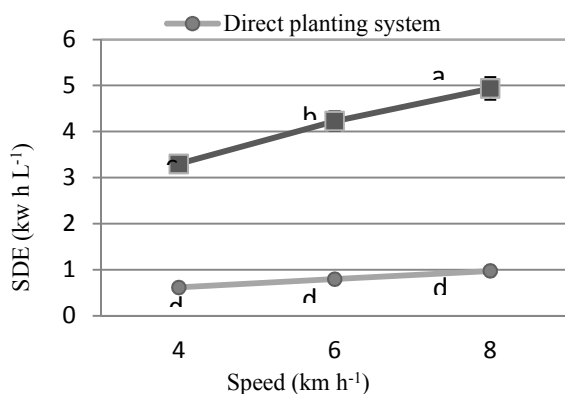

**Fig. 6.** Effect of cropping systems and speed on SDE. The same letters in columns show no significant differences based on Duncan test ( $p < 0.05$ )

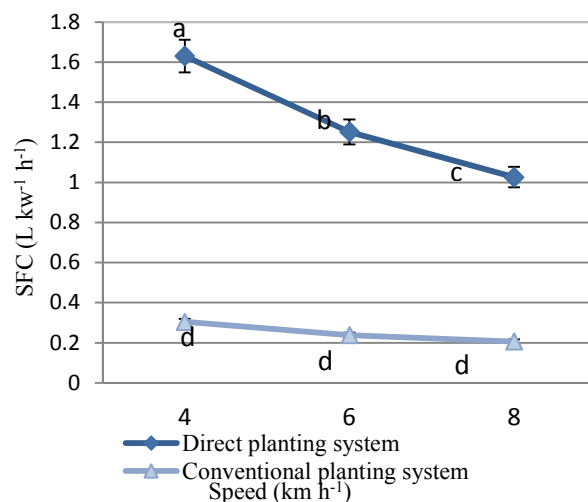

**Fig. 7.** Effect of cropping systems and speed on SFC. The same letters in columns show no significant differences based on Duncan test ( $p < 0.05$ )

**Clod Mean Weight Diameter (MWD)**

Tillage system did not show any significant effect on the clod MWD at confidence level of 5% (Table 2). This means that despite considerable differences between the two tillage systems, clod mean weight diameters was not significantly affected by the type of the farming system. The working depth of moldboard plow in the conventional system was greater than that of the direct planting system (20-25 cm compared to 6-7 cm). Therefore, the diameter of clods produced in the conventional system was more than that of the direct planting system. In the direct planting system, the work of the jointer is to plow up and throw a certain part of the upper layer of the soil on the furrow bottom. The clod MWD in the conventional tillage system after plowing and consequent disking was equal to clod MWD of conservation tillage with direct planting system. According to Fig. 8, for higher speeds, the clod MWDs are smaller. Therefore, there is an indirect relationship between clod MWD and plowing speed similar to the findings obtained by Kabiri and Zarean (2002).

**Relative Growth Rate (RGR)**

The system type and speed had not a significant effect on RGR at confidence level of 5% (Table 2). After a month from sowing wheat, the length and mass of roots and shoots of seedlings were measured. According to Table 4, the mean values of length and mass of root samples for the direct planting system were less than those in the conventional farming system while the length and mass of shoot were higher in one experiment. In botany, shoots consist of stems including their appendages, the leaves and lateral buds, flowering stems and flower buds.



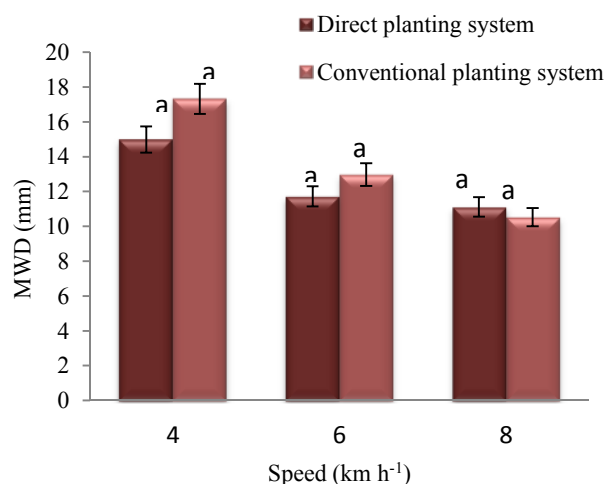

**Fig. 8.** Effect of cropping systems and speed on the MWD. The same letters in columns show no significant differences based on Duncan test ( $p < 0.05$ )

**Table 4.** Comparison of the mean values of length and weight of root and shoot in an experiment.

Treatment	Root length (mm)	Shoot length (mm)	Root weight (g)	Shoot weight (g)
Direct planting system	93 <sup>b</sup>	265 <sup>a</sup>	0.054 <sup>b</sup>	0.385 <sup>a</sup>
Conventional planting system	102 <sup>a</sup>	246 <sup>b</sup>	0.066 <sup>a</sup>	0.312 <sup>b</sup>

The same letters in columns show no significant differences based on Duncan test ( $p < 0.05$ )

Since plants have a high composition of water and the level of water in a plant will depend on the amount of water in its environment, using dry weight as a measure of plant growth tends to be more reliable. We could only capture this data as shoot weight once a final measure was made at the conclusion of our experiment.

We used dry root weight per plant (RW) and root length per plant (RL) as parameters for root mass which is recommended as a final measurement as the plant must be removed from its growing medium in order to capture accurate data.

In the direct planting system, the root penetration was less than that of the conventional system because the depth of soft soil layer was shallow. On the other hand, due to presence of surface residues, higher moisture and increase of soil organic matter, the shoot growth was better. Overall, the two factors neutralized the effect of each other and the results were similar to the conventional system. So, RGR values were not significantly different in the two planting systems.

### Moisture Content

One way to increase the water storage of the soil is to increase the water infiltration into the soil. Conservation tillage and cropping practices decrease runoff and increase water infiltration into the soil, which in turn protects the land from erosion.

In general, the properties of soil surface are the main factors affecting the water infiltration into the soil. Table 5 shows the average of soil moisture contents of 10 days after irrigation for two systems. The type of tillage system had a significant effect on soil moisture content ( $p < 0.05$ ). In the direct planting system, the moisture conservation increased at a rate of 1.87% compared to the conventional one.

**Table 5.** Comparison of the mean values of moisture content.

Treatment	Moisture content (%)
Direct planting system	13.52 <sup>a</sup>
Conventional planting system	11.65 <sup>b</sup>

The same letters in columns show no significant differences based on Duncan test ( $p < 0.05$ )

### CONCLUSIONS

Conservation tillage and direct planting resulted in reduced soil operations and planting times, SDE, fuel consumption and drawbar draft without any significant effect on stem growth increment. With a direct planting system, the wheel track area is untilled, which reduces energy requirements and increases field efficiency. Also, the soil which is worked requires less energy because it has not been compacted by wheel traffic. In addition, RGR was not significantly different for the two planting systems. Although, in direct planting system, the loose soil depth was less but the presence of surface residues, higher moisture content and the increase of soil organic matter with 68% decrease in the average time of operations were sufficient to recommend the direct planting system. MWD in conservation tillage was not significantly different compared to the conventional tillage system. Also, it was expected to reduce surface evaporation and increase water infiltration and absorption due to surface residues. The use of target direct seeding machine is recommended because it is more economical, and leads to energy conservation and saving of time.

### ACKNOWLEDGEMENTS

The authors wish to thank Research Council of Shiraz University, Shiraz, Iran, for providing necessary funds and research facilities required for this investigation.

## REFERENCES

- Bernacki, H., Haman, J., & Kanafojski, C.Z. (1972). *Agricultural machines theory and construction*. USA: U.S Department of Commerce, Springfield.
- Chen, H., Hou, R., Gong, Y., Li, H., Fan, M., & Kuzyakov, Y. (2009). Effects of 11 years of conservation tillage on soil organic matter fractions in wheat monoculture in Loess Plateau of China. *Soil and Tillage Research*, 106, 85–94.
- Coughenour, C.M. (2003). Innovating conservation agriculture: the case of no-till cropping. *Rural Sociology*, 68 (2), 278-304.
- Davies, D.B., & Finney, J.B. (2002). Reduced cultivations for cereals: research, development and advisory needs under changing economic circumstances. *HGCA Research Review*, 48, 1-59.
- Graham, J.P., & Ellis, F.B. (1980). The merits of precision drilling and broadcasting for the establishment of cereal crops in Britain. *ADAS Quarterly Review*, 38, 160-169.
- Jenane, C., Bashford, L.L., & Monroe, G. (1996). Reduction of fuel consumption through Improved tractive. *Journal of Agricultural Engineering Research*, 64(2), 131-138.
- Kabiri, K., & Zarean, S. (2002). Evaluation of draft requirement and soil inversion of moldboard plow at different levels of speed and plowing depth. *Journal of Agricultural Sciences and Natural Resources*, 9(2), 129-138. (In Persian).
- Kemper, W.D., & Chepil, W.S. (1995). Size distribution of aggregates. In Black, C. A. (Ed.), *Methods of Soil Analysis. Part I: Physical and Mineralogical Properties*. Madison: American Society of Agronomy, Soil Science Society of America.
- Liljedahl, J.B., Carleton, W.M., Turmquist, P.K., & Smith, W. (1989). *Tractors and their power units*. (4<sup>th</sup> ed.). New York: John Wiley&Sons.
- Maleki, s. (2002). Deck modeling for seismic analysis of skewed slab-girder bridges, *Engineering Structures*, Volume 24, Issue 10, October 2002, Pages 1315-1326
- Matthes, R.K., Watson, W.F., Savelle, I.W., & Sirois, D.L. (1988). Effect of load and speed on fuel consumption of a rubber-tired skidder. *Transactions of the ASAE*, 31(1), 37-39.
- Noggle, G.R., & Fritz, G.J. (1976). *Introductory plant physiology*. Minnesota: Prentice-Hall.
- OECD Standards Code 2. (2012). Oecd standards code for the official testing of agricultural and forestry tractor performance.
- Papendick, R. (2002). Managing soil cover and roughness. Farming with the wind. Department of Crop and Soil Sciences, Washington State University.
- Peruzzi, M., Raffaelli, M., & Ciolo, S.D. (1996). Evaluation of the performances of a peculiar combined machine for direct drilling and two no-till drills for hard winter wheat and maize cultivation. International conference on agricultural Engineering. Madrid.
- Regional Network for Agricultural Machinery. (1983). RNAM Test Codes and Procedures of Farm Machinery. Technical Series No. 12. Bangkok, Thailand.
- Spoor, G. & J. Godwin. 1978. An experimental investigation into the deep loosening of soil by rigid tines. *Journal of Agricultural Engineering Research*, 23:243-258.
- Stroosnijder, L. (2009). Modifying land management in order to improve efficiency of rainwater use in the African highlands. *Soil and Tillage Research*, 103, 247-256.
- Subbulakshmi, S., Harisudan, C., Saravanan, N., & Subbian, P. (2009). Conservation tillage – an ecofriendly management practices for agriculture. *Research Journal of Agriculture & Biological Sciences*, 5(6), 1098–1103.
- Taki, O. (1996). Evaluate and compare the distribution patterns of irrigated wheat seed planting using tillage-planting device. MSc. thesis. Shiraz University. Faculty of Agriculture. (In Persian)
- Tebrugge, F., Bohrsen, A. (2001). Farmers and experts opinion on no-tillage in Western Europe and Nebraska. In GarciaTorres, L., Benites, J., & Martinez Vilela, A. (Eds), *Conservation Agriculture. A World-wide Challenge*. Netherlands: Springer.
- Ward, R.C., Robinson, M. (1990). *Principles of Hydrology*. Maidenhead: McGraw- Hill.
- YounesiAlamouti, M., & Sharifi, B. (2011). Evaluation and determination of power amount, fuel required and some physical properties of soil in several tillage methods. *Journal of Agricultural Machinery*, 2(1), 18-11. (In Persian)



## ارزیابی مزرعه‌ای خطی کار مجهز به پیش‌خیش به منظور کشت مستقیم در بقایای گیاهی گندم

سوران عبدالله پور، سیدمحمد حسین کارپورفرد\*

گروه مهندسی بیوسیستم، دانشکده کشاورزی، دانشگاه شیراز، شیراز، ج.ا. ایران.

\*نویسنده مسئول

### اطلاعات مقاله

#### تاریخچه مقاله:

تاریخ دریافت: ۱۳۹۴/۴/۱۴

تاریخ پذیرش: ۱۳۹۵/۵/۶

تاریخ دسترسی: ۱۳۹۶/۴/۲۱

#### واژه‌های کلیدی:

ماشین کشت مستقیم

مصرف سوخت

پیش‌خیش

زمان کشت

انرژی ویژه مالبندی

**چکیده-** بخش اعظم انرژی مصرفی در کشاورزی سنتی مشتمل بر مصرف سوخت و استهلاک تراکتور و سایر ادوات مزرعه‌ای اعم از خاک‌ورز و کارنده‌های باشد. هدف اصلی از این پژوهش طراحی و ارزیابی یک واحد خاک‌ورز-کارنده سه پیش‌خیشی است. پیش‌خیش‌ها همانند شیار بازکن‌های معمولی به کار گرفته شده‌اند. عملکرد این واحد در مقایسه با بذرها‌های مرسوم ارزیابی گردید. گاو آهن‌بران‌دار به همراه دیسک کلوخه شکن چهارشاخه‌ای جهت خاک‌ورزی مرسوم و خطی کارپنوماتیک گندم به عنوان کارنده شاهد استفاده شد. زمین آزمایش با پوشش گیاهی گندم و با بافت رسی-لومی در تحت شرایط ۱۵/۲ درصد محتوای رطوبت (بر مبنای وزن خشک) مورد استفاده قرار گرفت. عمق کار برای واحدهای خاک‌ورز-کارنده کشت مستقیم و کارنده معمولی به ترتیب ۶ سانتیمتر و ۲۰ سانتیمتر در نظر گرفته شد. عملیات در سه سطح سرعت (۴، ۶ و ۸ کیلومتر بر ساعت) به همراه سه تکرار در مزرعه‌ای آزمایشی دانشگاه شیراز اجرا گردید. نتایج نشان دادند که زمان کشت، میزان مصرف سوخت، مقدار مقاومت کششی ویژه و انرژی ویژه مالبندی به ترتیب ۶۵٪، ۶۰٪، ۷۵٪ و ۸۰٪ در مقایسه با کارنده شاهد کاهش پیدا کرده است. مقادیر عددی مربوط به قطر متوسط وزنی کلوخه‌ها و نرخ رشد بذور در سطح احتمال ۵٪ تفاوت معنی‌داری برای دو نمونه کارنده نشان نداد. باندازه‌گیری محتوای رطوبتی خاک پس از ده روز میزان ذخیره رطوبتی در کشت مستقیم نسبت به کشت مرسوم ۱/۸۷٪ افزایش داشت.